



HANSA

Installation and maintenance guide



4-10



11-14



15



16



5312 2083

I (ISO 3822)
EN 817
50 - 1000 kPa
0.34 / 0.22 l/s (300 kPa)
300 kPa (0.3 l/s)
max. +65°C

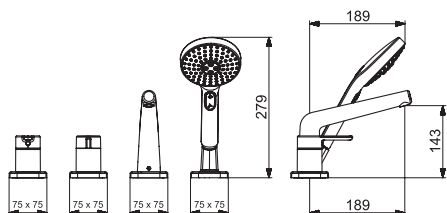

mpi.hansa.com/53122083

5325 9083

I (ISO 3822)
EN 817
50 - 1000 kPa
0.34 / 0.2 l/s (300 kPa)
300 kPa (0.2 l/s)
300 kPa (0.3 l/s)
max. +65°C

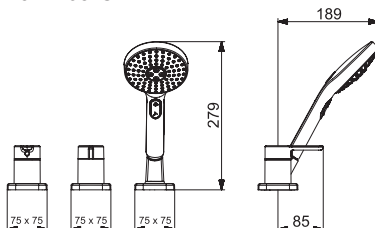

mpi.hansa.com/53259083

5312 2063

I (ISO 3822)
EN 817
50 - 1000 kPa
0.34 / 0.22 l/s (300 kPa)
300 kPa (0.3 l/s)
max. +65°C

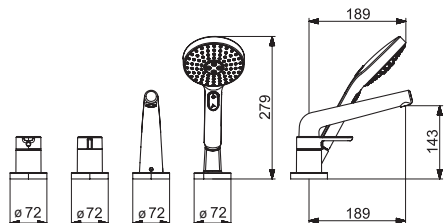

mpi.hansa.com/53122063

5325 9063

I (ISO 3822)
EN 817
50 - 1000 kPa
0.34 / 0.2 l/s (300 kPa)
300 kPa (0.2 l/s)
300 kPa (0.3 l/s)
max. +65°C

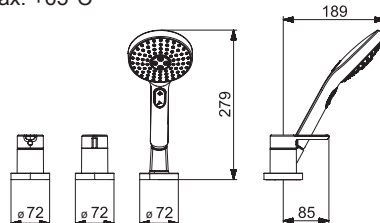

mpi.hansa.com/53259063



5775 2483

EN 817
50 - 1000 kPa
0.34 / 0.22 l/s (300 kPa)
max. +90°C

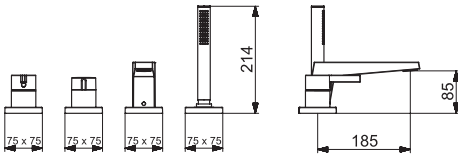
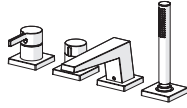

mpi.hansa.com/57752483

5779 9483

EN 817
50 - 1000 kPa
0.22 l/s (300 kPa)
max. +90°C

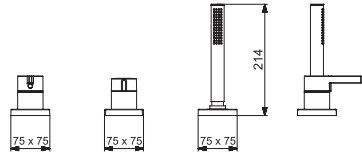
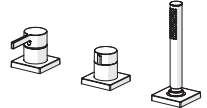

mpi.hansa.com/57799483

5775 2473

EN 817
50 - 1000 kPa
0.34 / 0.22 l/s (300 kPa)
max. +90°C

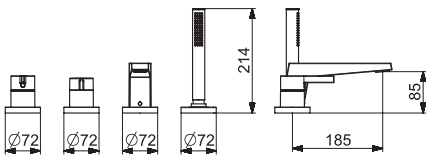
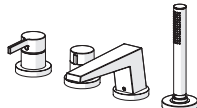

mpi.hansa.com/57752473

5779 9473

EN 817
50 - 1000 kPa
0.22 l/s (300 kPa)
max. +90°C

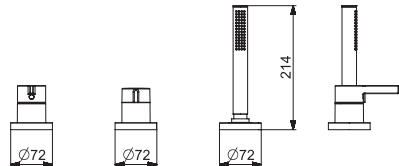
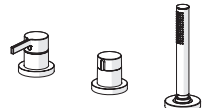

mpi.hansa.com/57799473



5730 2421

EN 817
50 - 1000 kPa
0.34 / 0.22 l/s (300 kPa)
max. +90°C

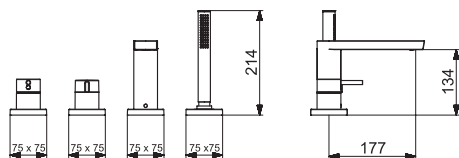
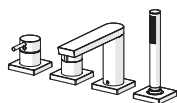

mpi.hansa.com/57302421

5731 9412

EN 817
50 - 1000 kPa
0.22 l/s (300 kPa)
max. +90°C

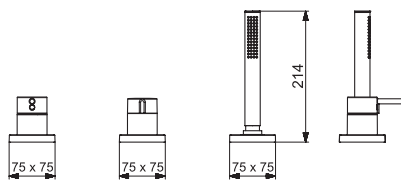
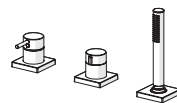

mpi.hansa.com/57319412

5730 2411

EN 817
50 - 1000 kPa
0.34 / 0.22 l/s (300 kPa)
max. +90°C

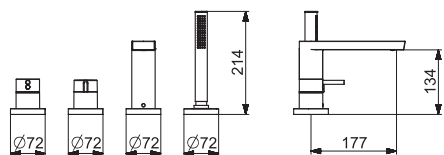
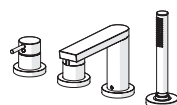

mpi.hansa.com/57302411

5731 9411

EN 817
50 - 1000 kPa
0.22 l/s (300 kPa)
max. +90°C

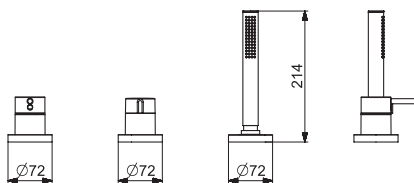
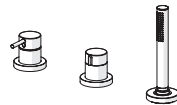

mpi.hansa.com/57319411



0340 2483

EN 817
 50 - 1000 kPa
 0.34 / 0.22 l/s (300 kPa)
 max. +90°C

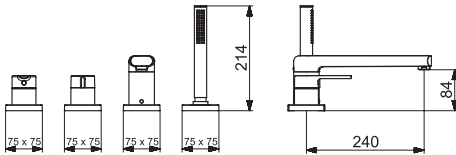
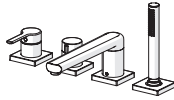

mpi.hansa.com/03402483

0341 9483

EN 817
 50 - 1000 kPa
 0.22 l/s (300 kPa)
 max. +90°C

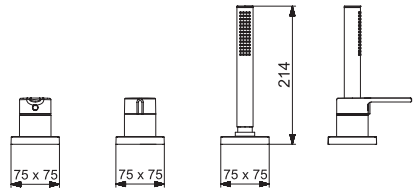
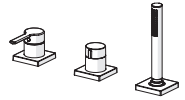

mpi.hansa.com/03419483

0340 2473

EN 817
 50 - 1000 kPa
 0.34 / 0.22 l/s (300 kPa)
 max. +90°C

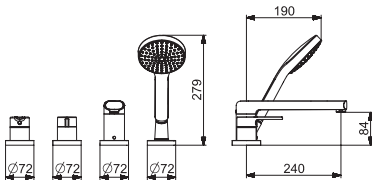

mpi.hansa.com/03402473

0341 9473

EN 817
 50 - 1000 kPa
 0.22 l/s (300 kPa)
 max. +90°C

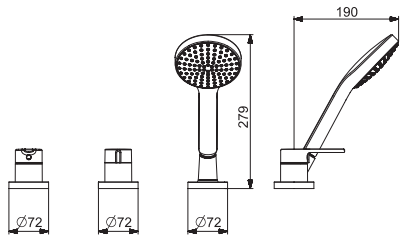

mpi.hansa.com/03419473

**0644 2493**

EN 817
50 - 1000 kPa
0.34 / 0.22 l/s (300 kPa)
max. +90°C

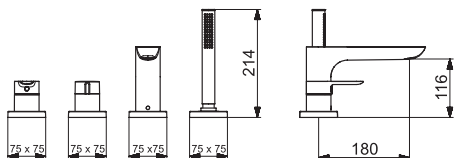
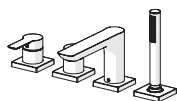
mpi.hansa.com/06442493**0643 9493**

EN 817
50 - 1000 kPa
0.22 l/s (300 kPa)
max. +90°C

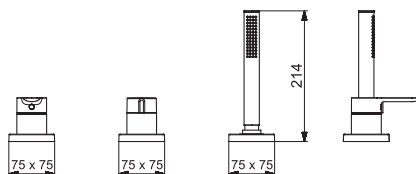
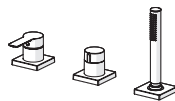
mpi.hansa.com/06439493**0644 2473**

EN 817
50 - 1000 kPa
0.34 / 0.22 l/s (300 kPa)
max. +90°C

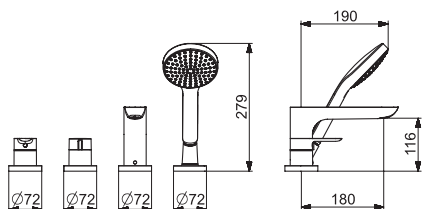
mpi.hansa.com/06442473**0643 9473**

EN 817
50 - 1000 kPa
0.22 l/s (300 kPa)
max. +90°C

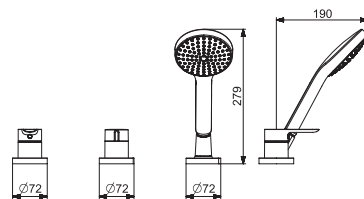
mpi.hansa.com/06439473



5730 2173

I (ISO 3822)
 EN 817
 50 - 1000 kPa
 0.34 l/s / 0.22 l/s (300 kPa)
 max. +80°C

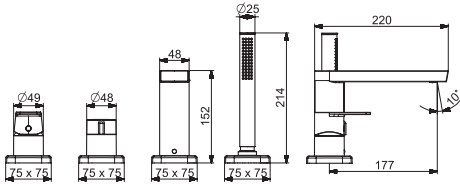
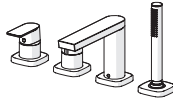

mpi.hansa.com/57302173

5731 9173

I (ISO 3822)
 EN 817
 50 - 1000 kPa
 0.34 l/s / 0.2 l/s (300 kPa)
 max. +80°C

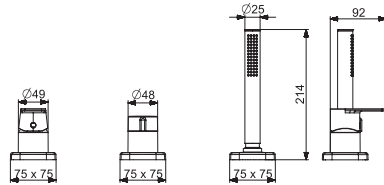
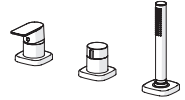

mpi.hansa.com/57319173

5730 2473

I (ISO 3822)
 EN 817
 50 - 1000 kPa
 0.34 l/s / 0.22 l/s (300 kPa)
 max. +80°C

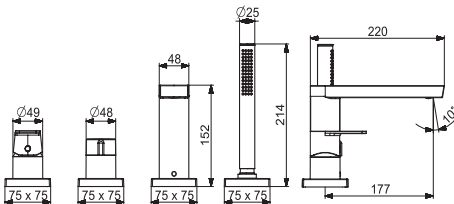
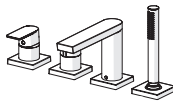

mpi.hansa.com/57302473

5731 9473

I (ISO 3822)
 EN 817
 50 - 1000 kPa
 0.34 l/s / 0.2 l/s (300 kPa)
 max. +80°C

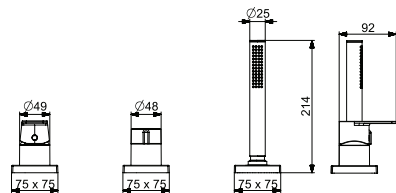
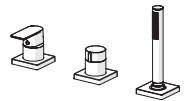

mpi.hansa.com/57319473



5354 9420

EN 1112
50 - 500 kPa
0.22 l/s (300 kPa)
max. +65°C

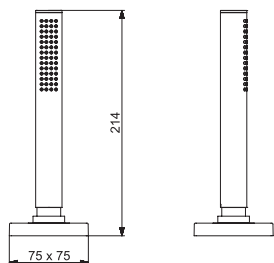

mpi.hansa.com/53549420

5324 9440

EN 1112
50 - 500 kPa
0.22 l/s (300 kPa)
max. +65°C

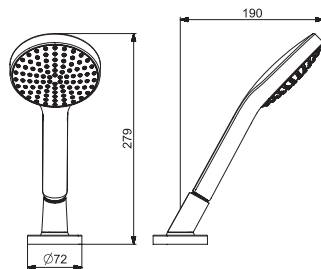

mpi.hansa.com/53249440

5354 9470

EN 1112
50 - 500 kPa
0.25 l/s (300 kPa)
max. +65°C

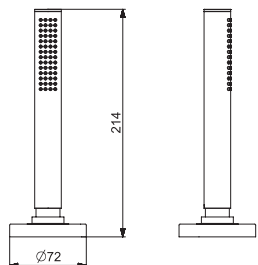

mpi.hansa.com/53549470

5728 1000

EN 1112
50 - 500 kPa
0.22 l/s (300 kPa)
max. +65°C

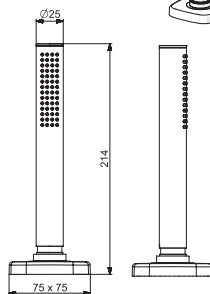
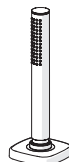

mpi.hansa.com/57281000

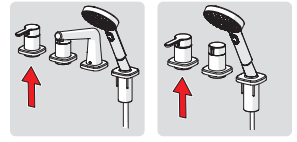
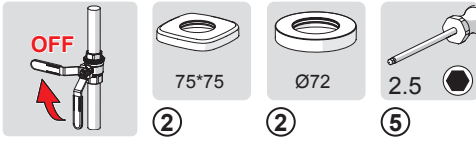

1

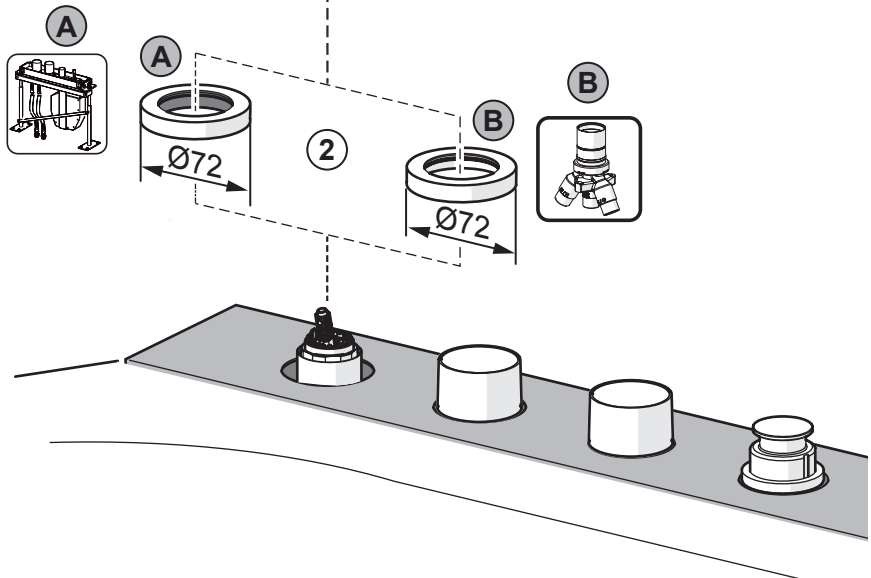
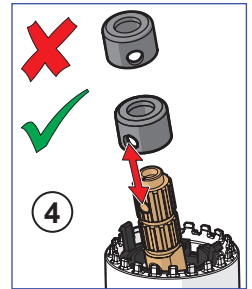
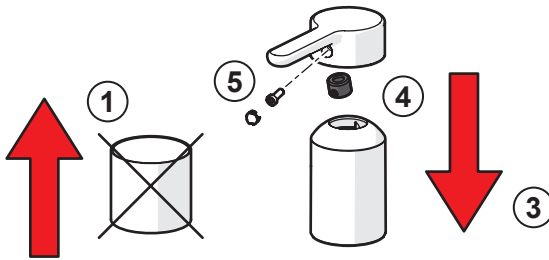

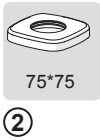
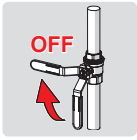

2

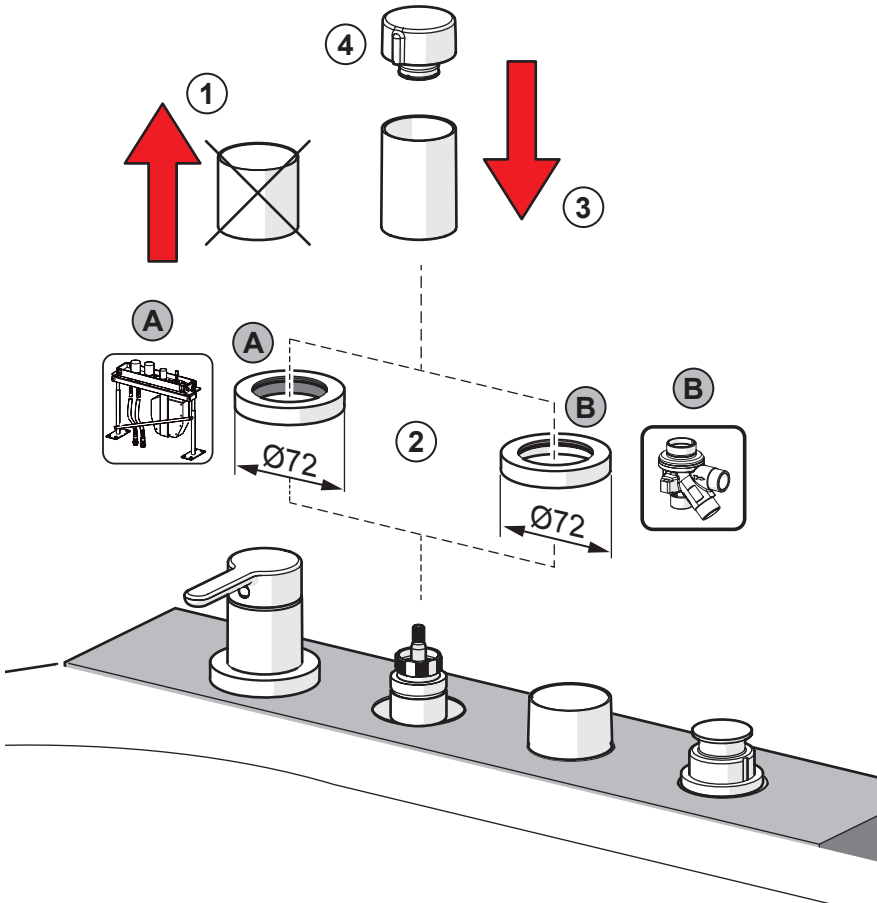

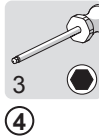
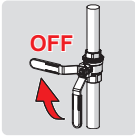

3

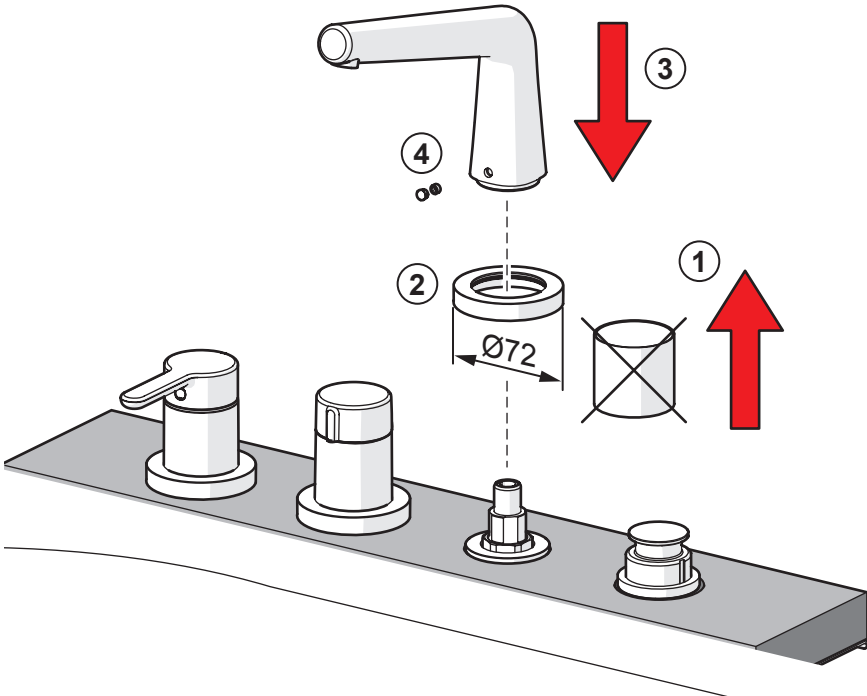
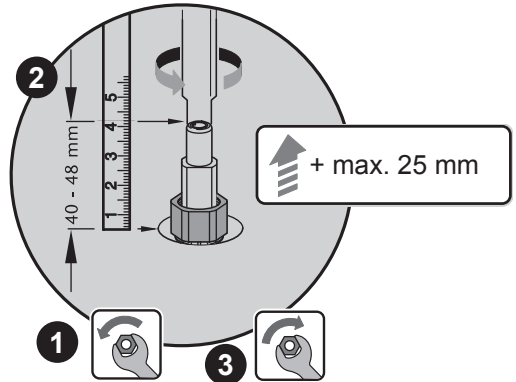

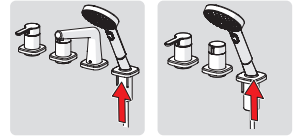
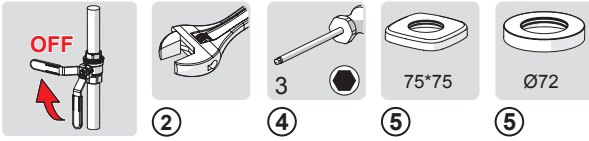

4

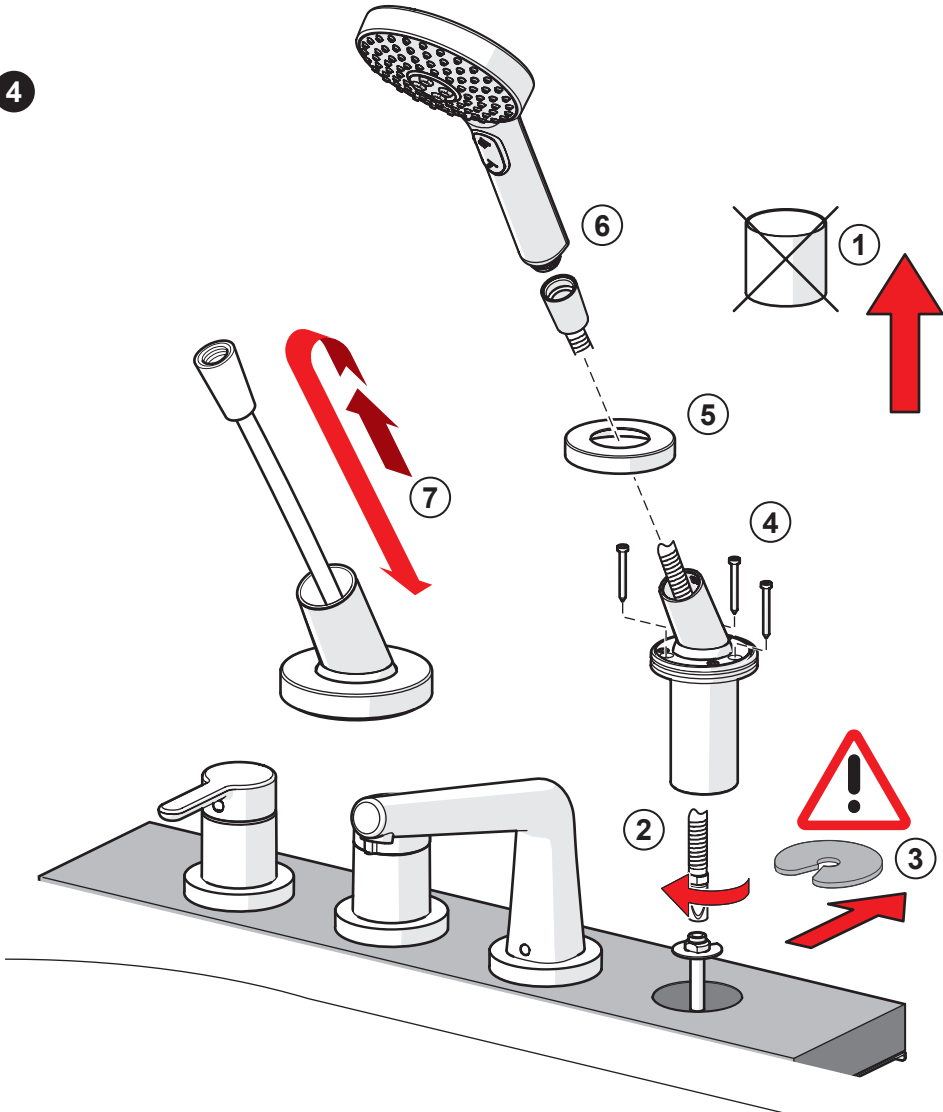

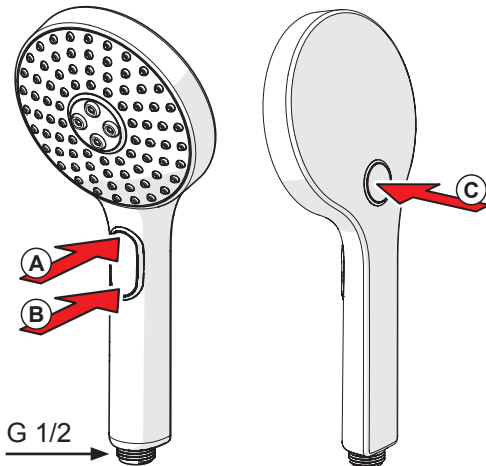
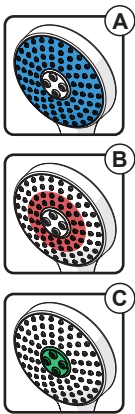
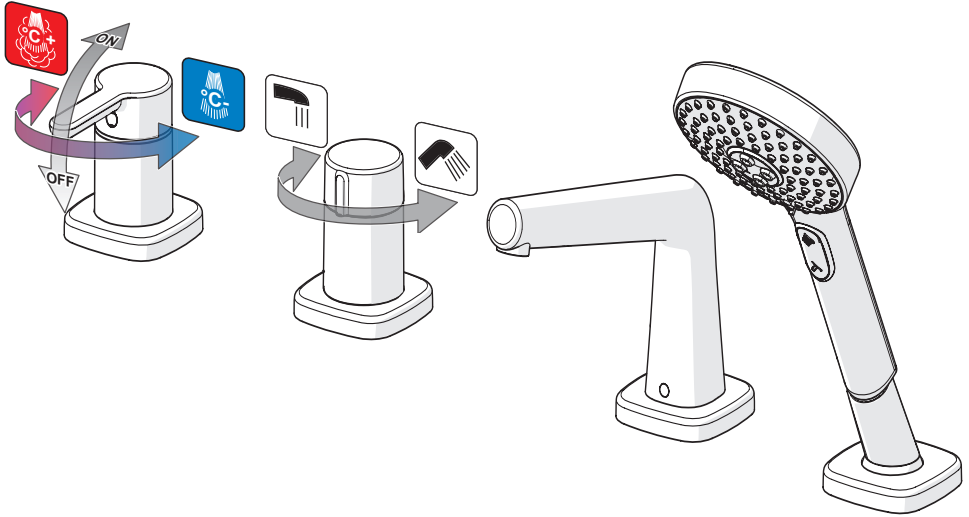
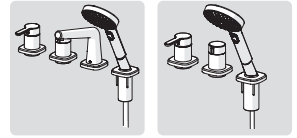

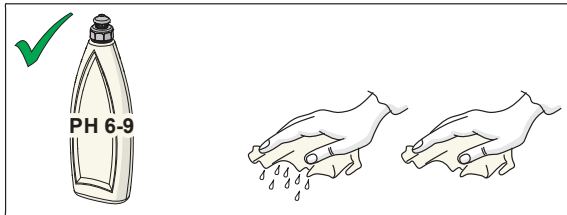
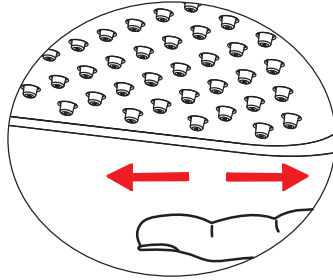

cleaning.hansa.com

Oras Group is a powerful European provider of sanitary fittings: the market leader in the Nordics and a leading company in Continental Europe. The company's mission is to make the use of water easy and sustainable and its vision is to become the European leader of advanced sanitary fittings. Oras Group has two strong brands: Oras and Hansa.

The Group's head office is located in Rauma, Finland, and the Group has three manufacturing sites: Kralovice (Czech Republic), Olesno (Poland) and Rauma (Finland). Oras Group employs approximately 1,200 people in twenty countries. Oras Group is owned by Oras Invest, a family company and an industrial owner.

HANSA Armaturen GmbH
P. O. BOX 81 02 40
D-70519 Stuttgart
Sigmaringer Strasse 107
D-70567 Stuttgart
Tel.: +49 711 16 14 0
Fax: +49 711 16 14 368
info@hansa.de
www.hansa.com



943319D-10-20