



HANSA

Installation and maintenance guide





4-8



8985 9083, 8985 9083 33

EN 817
50 - 1000 kPa
0.37 l/s (300 kPa)
max. +90°C

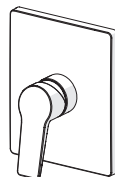
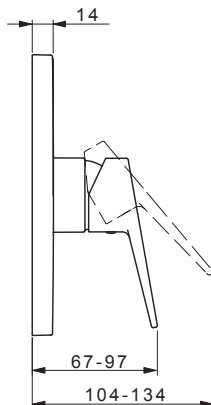
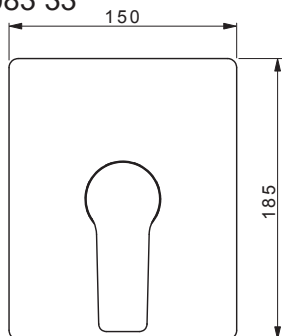

mpi.hansa.com/89859083

8984 9083, 8984 9083 33

EN 817
50 - 1000 kPa
0.35 / 0.35 l/s (300 kPa)
max. +90°C

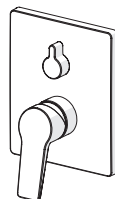
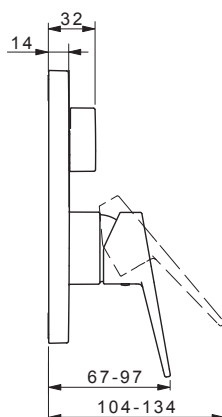
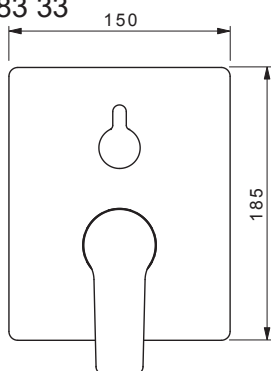

mpi.hansa.com/89849083

8984 3083

EN 817
50 - 1000 kPa
0.35 / 0.35 l/s (300 kPa)
max. +90°C

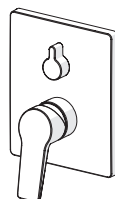
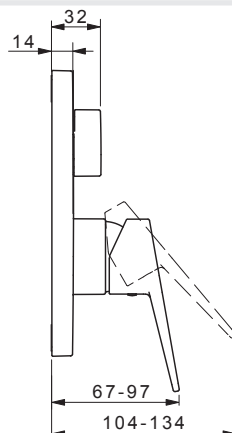
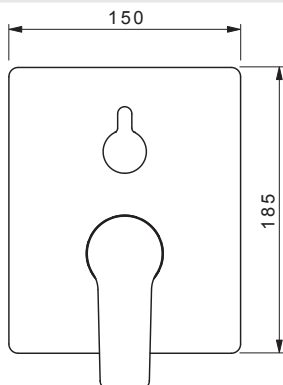

mpi.hansa.com/89843083

**8985 9085**

EN 817
50 - 1000 kPa
0.37 l/s (300 kPa)
max. +90°C

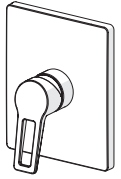
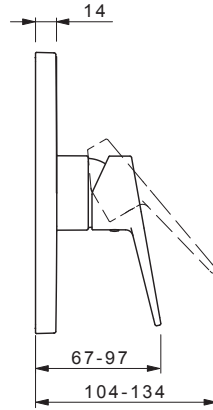
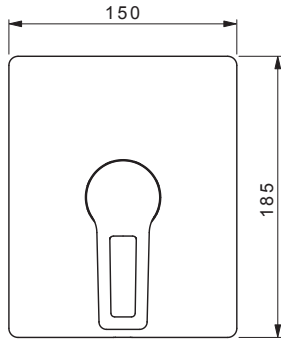

mpi.hansa.com/89859085

8984 9085

EN 817
50 - 1000 kPa
0.35 / 0.35 l/s (300 kPa)
max. +90°C

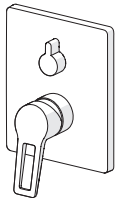
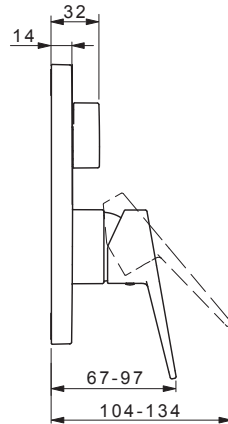
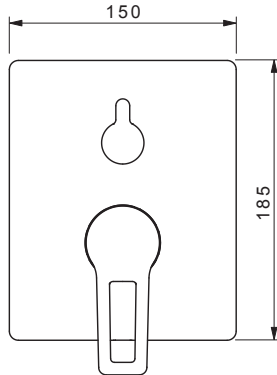

mpi.hansa.com/89849085

8984 3085

EN 817
50 - 1000 kPa
0.35 / 0.35 l/s (300 kPa)
max. +90°C

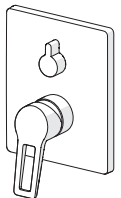
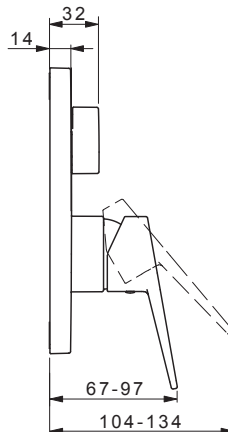
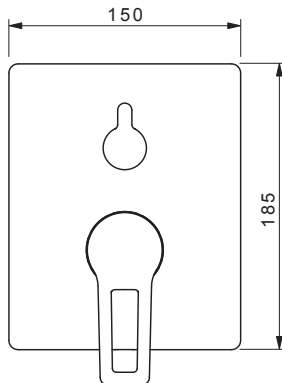

mpi.hansa.com/89843085



8061 9093

EN 817
50 - 1000 kPa
0.37 l/s (300 kPa)
max. +80°C

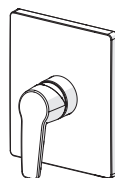
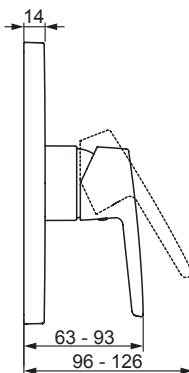
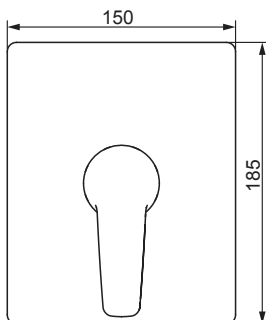

mpi.hansa.com/80619093

8060 9093

I(ISO 3822)
EN 817
50 - 1000 kPa
0.35 / 0.35 l/s (300 kPa)
max. +80°C

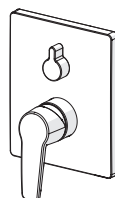
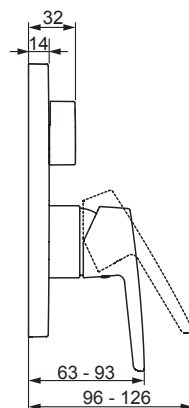
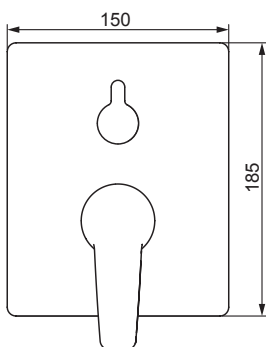

mpi.hansa.com/80609093

8062 3093

50 - 1000 kPa
0.35 / 0.35 l/s (300 kPa)
max. +80°C

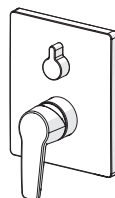
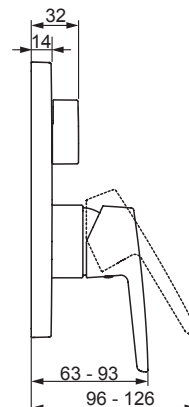
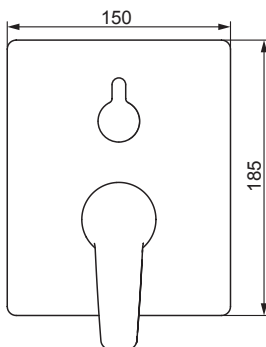

mpi.hansa.com/80623093



8627 9103

EN 817
50 - 1000 kPa
0.37 l/s (300 kPa)
max. +90°C

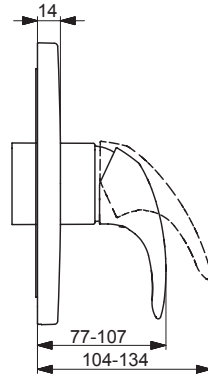
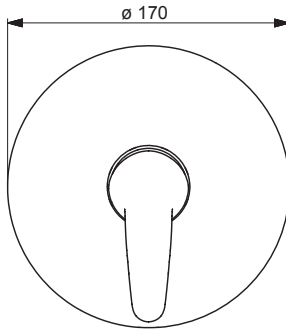

mpi.hansa.com/86279103

8626 9103

EN 817
50 - 1000 kPa
0.35 / 0.35 l/s (300 kPa)
max. +90°C

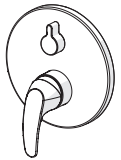
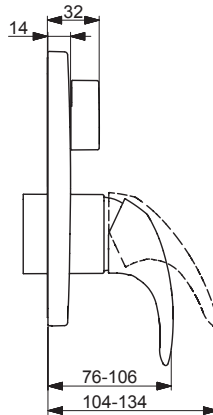
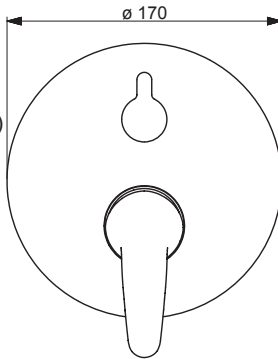

mpi.hansa.com/86269103



8051 9001

I(ISO 3822)
EN 817
50 - 1000 kPa
0.37 l/s (300 kPa)
max. +90°C

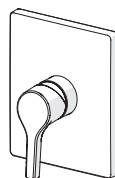
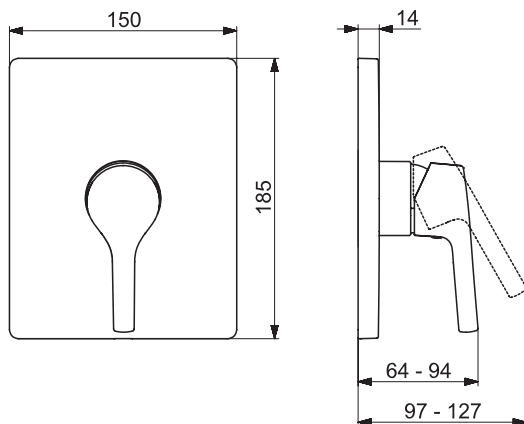

mpi.hansa.com/80519001

8050 9001

I(ISO 3822)
EN 817
50 - 1000 kPa
0.34 / 0.22 l/s (300 kPa)
max. +90°C

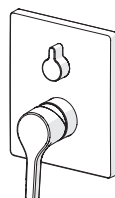
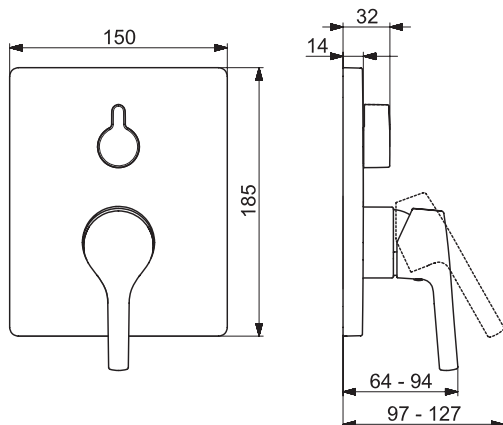

mpi.hansa.com/80509001

8050 3001

I(ISO 3822)
EN 817
50 - 1000 kPa
0.34 / 0.22 l/s (300 kPa)
max. +90°C

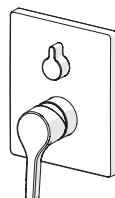
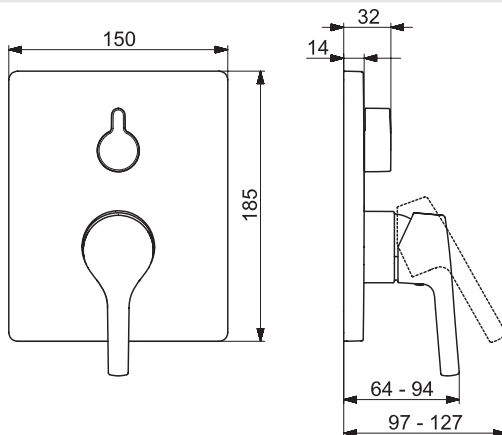

mpi.hansa.com/80503001

Oras Group is a powerful European provider of sanitary fittings: the market leader in the Nordics and a leading company in Continental Europe. The company's mission is to make the use of water easy and sustainable and its vision is to become the European leader of advanced sanitary fittings. Oras Group has two strong brands: Oras and Hansa.

The Group's head office is located in Rauma, Finland, and the Group has three manufacturing sites: Kralovice (Czech Republic), Olesno (Poland) and Rauma (Finland). Oras Group employs approximately 1,200 people in twenty countries. Oras Group is owned by Oras Invest, a family company and an industrial owner.

HANSA Armaturen GmbH
P. O. BOX 81 02 40
D-70519 Stuttgart
Sigmaringer Strasse 107
D-70567 Stuttgart
Tel.: +49 711 16 14 0
Fax: +49 711 16 14 368
info@hansa.de
www.hansa.com



943246D-01-21